

# KRETA

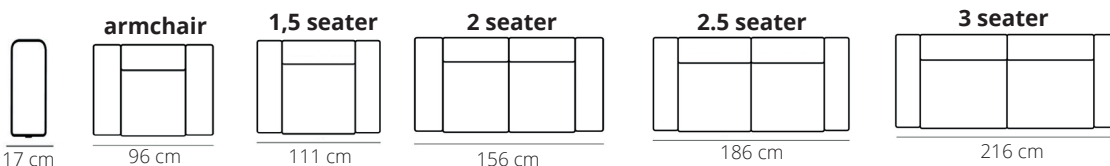

## ELEMENTS

### Sizes with small arm



### Sizes with wide arm

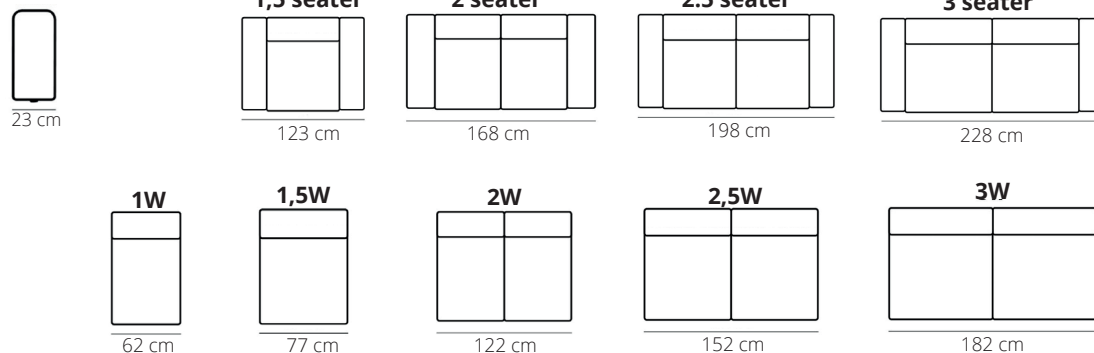

### AL-LK (arm left) LK-AR (arm right) AL-LG (arm left) LG-AR (arm right)

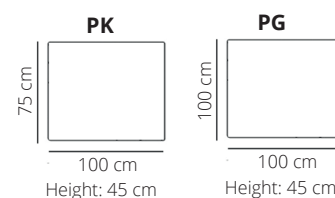
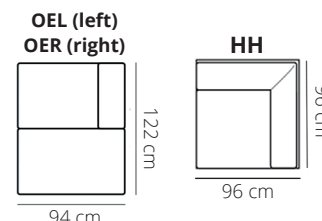
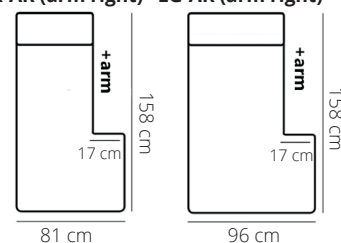

## STITCHING



open seam

### HELLAS

only available in leather or L60 oklakoma/Colorado and fabrics Hunter



pinched seam

### KRETA

available in leather and fabrics

## LEGS



J-127  
black

HEIGHT: 77 cm  
DEPTH: 94 cm  
SEAT DEPTH: 57 cm  
SEAT HEIGHT: 45 cm  
ARM HEIGHT: 60 cm

## PRODUCT INFO

### FRAME



beechwood



chipboard

### FILLING

BACK



foam SG 28



fibre wool

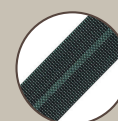

elastic belts

SEAT

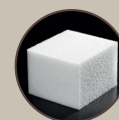

foam SG 40



fibre wool



no-sag springs



SKIPPY Meubel