

 **Flow Sensors**



Special-Sensors for Automation

Flow Sensors

Contents

Technique and application for flow sensors

Technique and application for flow sensors, amplifiers and compact models	1.3 - 1.7
Terminology / Setting instructions	1.8 - 1.10
Detection of microflow impulses	1.10 - 1.11
Technique and application for flow sensors inline-digital display	1.11 - 1.12
Ex area certification / Notes on safety applications	1.12 - 1.13
Technique and application IO-Link, sensors with IO-Link	1.14 - 1.19

Flow sensors Series 400 / Series 500

Probes Series ST / STK	1.22 - 1.25
Probes high temperature 120 °C/160 °C Series ST	1.26 - 1.28
Probes chemical resistant Series STA	1.29
Compact models Series SC 440 / SCS 440	1.30 - 1.31
Compact models Series SNS 450 / SN 450	1.32 - 1.36
Compact models with analog output Series SNS 450 / SN 450	1.37 - 1.38
Compact models with two switching points Series SN 450	1.39
Compact models with temperature controll Series SNT 450	1.40 - 1.42
Compact models with turn on/off delay Series SN 450	1.43
Inline-Sensor Series SD	1.44 - 1.45
Inline-Compact Series SDN / SDNC / SDNC with IO-Link	1.46 - 1.54
Special-Probe Food / Pharma Series SCB / STB / STC	1.55
Inline-Compact Series SDB / SDN	1.56 - 1.57

Flow sensors with digital display Series SDN / SDV / SDI

Compact model with digital display Series SNS 552	1.58
Inline-Compact with digital display Series SDN 552 / SDN 554	1.59 - 1.63
Vortex-Measuring device with digital display Series SDV 652	1.64
Magnetic flowmeter with digital display Series SDI 852 / SDI 853	1.65 - 1.66

Air flow sensors Series 400 / Series 500 / Series 1000

Probes Series LTZ 421	1.67
Compact models Series LN / LG	1.68
Compact models screw-on mounting Series LNZ 450	1.69 - 1.71
Compact models sleeve mounting Series LN 450	1.72 - 1.74
Inline-Compact air flow Series LDN	1.75
Air flow sensors with IO-Link Series LDN / LDV / LDS	1.76 - 1.78

Amplifiers for sensors

Amplifiers Series SKM / SKZ	1.79 - 1.83
-----------------------------	-------------

Flow sensors, air flow sensors and amplifiers for Ex-applications

Ex-Probes Series STS / ST – Category 1 / Category 2	1.86 - 1.95
Ex-Probes Series STS / ST – Category 1 / Category 2 with flange	1.96 - 1.99
Ex-Probes Series STSEX – Category 1 with terminal clamps	1.100
Air flow Ex-Probes Series STS – Category 1 / Category 2	1.101 - 1.103
Amplifiers Series SZA	1.104 - 1.105
Air flow sensors Compact models Series LC 518 / LC 521 – Category 3	1.106 - 1.109
Ex junction box Series GK – Category 2	1.110 - 1.112

Accessories

IO-Link Master	1.113
M12 connector / Cable	1.114 - 1.116
Assembly parts	1.117 - 1.118

Technical alterations are reserved to us without prior announcement.

Flow Sensors

Technique & Application

Function

The function of the flow controller is based on the thermodynamic principle. The sensor is heated internally a few degrees °C compared to the medium into which it projects. When the medium flows, the heat generated in the sensor is conducted away by the medium, i. e. the sensor cools down. The temperature within the sensor is measured and compared to the temperature of the medium. The state of flow can be derived for each medium by the temperature difference attained.

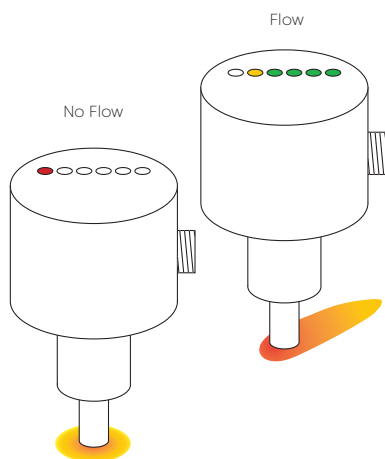

Function of thermodynamic flow controllers

On the basis of this functional principle EGE manufactures flow monitors for liquid and gaseous media.

The sensitivity of thermodynamic flow monitors depends on the thermal characteristics of a medium. The detection range of a standard sensor for oil, for example, is three times as great than for water and for air is approx. 30 times greater than for water due to the reduced heat conductivity. Unless stated otherwise, the technical sensor data are specified for water.

Areas of application for flow monitors

Thermodynamic flow monitors function without any moving parts, therefore they are not subject to failure due to corroded bearings, torn impellers or deflector deformation. This reliability is highly valued in many industries. Today, flow monitors are used both in liquids and in air, and are employed even in explosion hazardous environments.

Monitoring of cooling

- The cooling water on welding machinery is monitored using compact stainless steel devices. This ensures sufficient cooling even for rapid cycles, otherwise the welding robot will be switched off by the sensor.
- The cooling lubricant flow is monitored continuously in processing centres. The tools are protected and have a greater service life.
- In metal processing, e.g. rolling mills and wire drawing machines, the rolls and coils will be cooled continually. This is monitored by thermodynamic sensors. Due to the rough environmental conditions the sensors are designed for up to 160 °C and settings are made away from the heat with special amplifiers.

Monitoring of flow medium

- The run-dry protection of pumps is a frequent application, which often uses compact sensors with time delay.
- In dosing technology the aggregate, usually small flow quantities, is measured exactly by means of inline sensors. These sensors are inserted like a pipe into the line.
- Monitoring of filters and sieves can be ensured by medium flow control; if the flow is progressively reduced, the filter must be renewed. Where this is not carried out, the pump is switched off in a second stage should the medium flow drop further. This uses a sensor with two switching points.

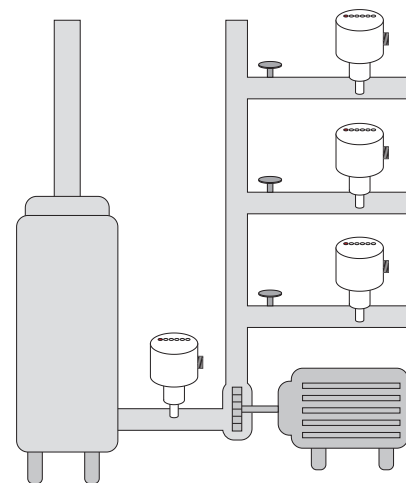

Run-dry protection of a feed pump

Monitoring of process flow

- The monitoring of cleaning processes using aggressive media at times is often only possible with special materials, e.g. hastelloy or tantalum.
- Extraction systems for hazardous vapours at laboratory workstations as well as the hall ventilation in the hexane processing industry are monitored using airflow sensors.
- CIP/SIP processes can be monitored and documented with flow monitors.

Flow Sensors

Technique & Application

Probes

The temperature-sensitive measuring elements are fitted in the tip of the probe. The probe tip and the adjoining thread/mounting part are made in one piece of stainless steel in many probes. This guarantees absolute tightness and high compressive strength. Special materials are used in corrosive, and particularly in oxidizing media, since stainless steel shows only limited resistance to corrosion in this application. In standard applications, probes can be mounted independently of the direction of flow of the medium. In any case, it is important to make sure that the pin of probe is completely surrounded by the medium to be monitored. Please note that for smaller cross-sections the sensor tip narrows the tube's cross-section. This results in a higher flow rate.

In order to avoid malfunctions caused by unstable flow patterns no fittings that could affect the flow cross-section or the flow direction should be placed directly in front of and behind the sensor. The point of reference for the input/outlet section is approximately 5 to 10 times the tube diameter.

Assembly

Probes with short thread-pieces of the STK... type are particularly suited for fitting into T-pieces. Sensor length is designed in such a way that the probe tip is completely immersed in the medium without touching the opposite side.

Probes with long thread-pieces of the ST... type are suitable for larger pipe diameters or for use with longer assembly thread-pieces. Probe threads are G-pipe threads to DIN ISO 228 and also comply with the BSP standard. A flat gasket centered by a step on the sensor ensures a good seal. A good seal can also be ensured using Teflon tape. For pressure above 30 bar or very high screw-down torques, a flat gasket may be damaged, especially if it is made of plastic. In this case, a recess must be incorporated into the fitting which will keep the gasket in the right position in the case of high loads.

PTFE gaskets must always be used with this technique. For high pressure applications, metal gaskets must be used. The standard material for gaskets is AFM 30/34. Special gaskets made of other materials such as moving iron, copper or PTFE are also available on request.

Dimensions of the gasket

Thread	d	D	h	t
G1/4	13.2	19.5	1.5	1
G1/2	21	27.5	2	1.5
G3/4	26.5	32.5	2	1.5

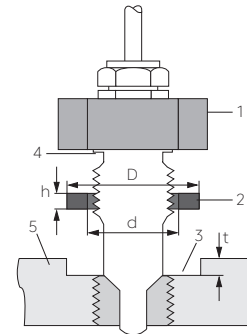

(1) Probe (2) Gasket (3) Chamber
(4) Edge (5) Counterpart

A rising pipe should be used in case of open systems or in the presence of air pockets (1). Deposits and air pockets do not impair sensor function in the case of lateral assembly (2), providing the sensor is completely immersed in the medium.

Assembly from below (3) assures flow monitoring function even if there are air pockets in the pipe. However, the monitored medium level must not fall below the upper edge of the measuring tip. Assembly from above is only applicable if there is no air in the pipe.

1. Installation in rising pipe

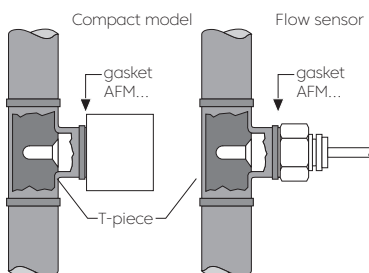

2. Lateral installation

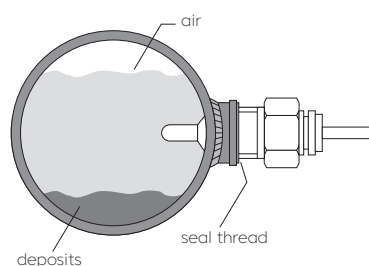

3. Underside installation

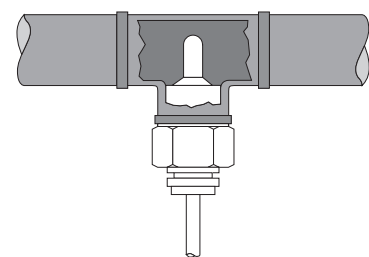

Flow Sensors

Technique & Application

NPT threads

NPT threads can be provided as an alternative for all types which have a G1/2 or a G3/4 thread. NPT threads are conical and must be screwed into an equally conical counter-part. Two types of NPT threads must be distinguished. NPT thread according to ANSI B 1.20.1 does not ensure a good seal by itself and requires the use of a sealing medium, e.g. Teflon tape. It is not possible to use flat gaskets with this type of thread.

Flange types

Standardised pipe connections are required particularly in the chemical, pharmaceutical and foodstuff industries. Sensors for use in these areas are supplied with flange connections per DIN or ASME. Sensor and flange form a corrosion-proof connection using laser or inert gas shielded arc welding.

Food-approved screw connections

For hygienic reasons the food and pharmaceutical industries place special demands on the mechanical and electronic characteristics of sensors.

Probes with food-approved connections, e. g. Triclamp or dairy pipe connections (DIN 11851) comply with the 3-A sanitary standard 28-05. Due to the temperature changes involved, the usual cleaning cycles CIP and SIP place a particular demand on sensor electronics. Therefore, special protective measures are taken. Sensor materials for these applications is mainly the special steel AISI 316 L. Customer-specific connections, e. g. GEA-Varivent or APV flanges are available, as are other special metallic materials.

Extra long probes

Flow probes are available in screw lengths of 25 mm to 300 mm. The probe length should be selected such that the measuring tip is within an area of stable flow characteristics.

Main applications are:

- detection of small flow velocities in pipes with large cross section
- mounting of the sensor with a standard flange
- use of extra long welding sleeves if the piping is surrounded by a supplementary insulation.

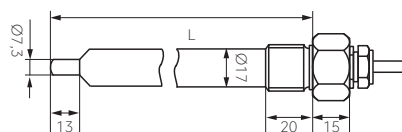

Long sensor

Immersion depth "L" is determined by the distance between the sealing face and the sensor tip. Standard lengths which can be supplied are: L = 80 and 120 mm; in the Ex-area 80, 110 and 140 mm.

Inline

Inline sensors are inserted directly into the line of a pipe. This design does not feature any measuring pins protruding into the flow. EGE inline sensors SD of series 500 are suitable for flow volumes from 0.5 ml/min to 6 l/min. These sensors excel through smooth measuring pipes, low pressure loss and fast response to flow changes. A multitude of connection options are available.

Chemical stability of probe housings

The chemical stability of the materials used must be verified individually for every application. Basically, no problems occur if the probe and the piping are made of the same material. It is always advantageous if the sensor housing is made of a more noble material than the piping.

The screwed cable gland on the rear side of the ST... sensors is designed in nickelplated brass. Order material PVDF for screwed cable glands in applications that are cleaned with alkaline cleaning agents as is the case, for example, in the food industry.

Stainless Steel belongs to the group of chromium-nickel alloys containing further components such as molybdenum or titanium. The proportions of the different alloy components is critical to the resistance to corrosion in the medium. For this reason, there exists a large number of materials identified by numbers to the DIN EN ISO 7153-1:2000 standard. Due to its good corrosive resistance in many areas of application, AISI-316 Ti (VA4) stainless steel is a frequently used material.

It may be used in installations used to obtain water, in air conditioning systems, in food processing industries such as dairy products, meat products, beverages, wine production or in kitchen installations. Stainless steels have a restricted stability in chlorinated or poorly oxygenated atmospheres. Special alloys must be used for such applications.

Flow Sensors

Technique & Application

Special materials

Hastelloy B-2 (2.4617) belongs to the group of highly corrosion-resistant nickel-molybdenum alloys.

This material has excellent characteristics in reducing media, e.g. in hydrochloric acid of any concentration and for a large range of temperatures. It can also be used in hydrochloric, sulphuric, acetic and phosphoric acid media. Good resistance against corrosion such as pitting, crevice corrosion, chlorine induced stress, corrosion cracking, hair-line corrosion, abrasion and corrosion within the heat influence zone allows for a large range of applications. In the presence of oxidising components such as iron or copper salts, the use of this material is not recommended.

Hastelloy C-22 (2.4602) belongs to the group of high corrosion-resistance nickel-chromium-molybdenum-tungsten alloys. The material is characterised through high resistance against crevice corrosion, pitting and stress corrosion cracking in oxidising and reducing media. It also displays good behavior in the presence of a large number of corrosive media, including strong oxidants such as iron (III) chloride and copper (II) chloride, hot media, e.g. sulphuric acid, nitric acid, phosphoric acid, chlorine (dry), formic acid and acetic acid. Furthermore, it has satisfactory characteristics in humid chlorine gas, as well as in sodium hypochlorite and chlorine dioxide solutions.

Titanium (3.7035) is a light metal with mechanical strength values equivalent to those of high quality steel. The good chemical resistance of this metal is due to the fact that an oxide film is formed on its surface, as is also the case with stainless steels. If this protective layer undergoes mechanical damages in an oxygenated environment, it is immediately renewed (titanium will resist even aqua regia). Titanium is not stable in environments containing no oxygen or in reducing environments. It is particularly suitable for applications in chloride-containing media. Experience in the chemical industry and in paper bleaching factories has shown that titanium is the only material allowing undisturbed production. The excellent characteristics of titanium also give optimum results in sea water cooling systems and sea water de-salinating plants.

The material is particularly suited for the application of coating with other metals and metal ceramics. These supplementary coatings noticeably increase its chemical stability and thus the lifetime of sensor housings.

High temperature

High temperature sensors are manufactured from temperature-resistant components and feature FEP cables. The functional range of these special probes of series 400 is specified as +10...+120 °C. Temporarily 135 °C is permissible for max. 10 min. High temperature sensors of series 500 can be used for media temperatures of up to 160 °C / 320 °F.

Connection

Flow monitoring probes are available with a M12 plug connector or fixed cable. Special models have a terminal compartment. The connection cable from the probe to the amplifier may be up to 100 m long. For distances above 30 m a shielded cable is preferred. In all cases the chosen wire strength must be checked against the requirements.

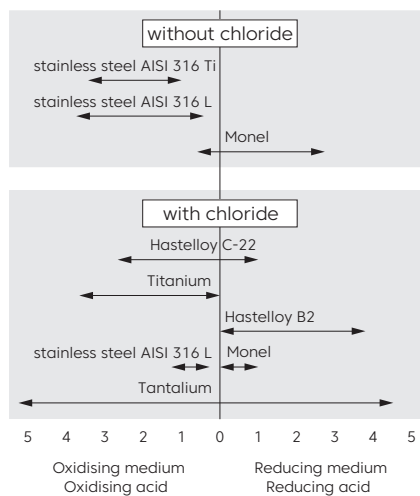

Chemical resistance of B3-coating

Medium	Cl ₂	HCl (25%)	Br ₂	HBr (20%)	F ₂ (15%)	HF (15%)	HA (general)	NaOH	Salzw. (Kestern)	red. Medien	HNO ₃ (30%)	H ₂ SO ₄ (25%)
Resistance	+++	+++	+++	+++	+	+	+++	++	+++	++	++	+++

HA general = Acid. acid in different concentrations
 Salzw. Kestern = Saltwater-Kesternich-Test
 Resistance = proofed up to 30°C

Coating properties
 The coating is hard to wear and resistant to abrasive substances in media like for example chalk, mud, sand and fiber.

Flow Sensors

Technique & Application

Amplifiers

All amplifiers have a multicolour LED display which visually indicates the flow tendency. If the LED light is red, the pre-installed limit value is not reached and the switching output is not activated. The yellow LED indicates that the limit value was reached and the output is active. In addition to the yellow LED, 4 more green LEDs can light up to indicate how much the limit value is exceeded.

For the installation of the amplifiers, make sure that the devices are not subject to heat build-up. The distance between adjacent devices should not exceed the value specified in the instruction manual.

Amplifiers SKZ... and SKM...

The terminal rail devices SKZ... and SKM... are prepared for installation on the top hat rail. They evaluate the signals delivered by the measurement probes and provide relays or analog outputs. The settings are made using two potentiometers that are accessible from the front or via buttons for SKM 522. In addition, SKZ amplifiers provide a switch-off delay as well as temperature monitoring.

Ex amplifier SZAb...

For Ex measurement probes, the SZAb... amplifiers with relay or analog output are offered. They have an intrinsically safe circuit to which the measurement probe is connected. This safe circuit is galvanically isolated from the mains and the relay or analog output. The Ex amplifiers SZAb... must be set up outside of the hazardous area.

Compact devices

Compact devices integrate amplifier and probe within one housing. This permits setting a limit value directly at the measuring location. The cabling is thus reduced to the less interference-prone mains supply cables and the switching output.

Screw assembly

SC 440.../SN 450.../LN 450.../LNZ 450...

Compact devices of the series mentioned can be easily assembled in screw adapters, bushings and T-pieces. To this end the measuring probes usually have a thread of size G1/4, G1/2 or NPT1/2. Many other options can be implemented as special device. The devices of series SC 440... are completely manufactured from stainless steel and characterised by robustness and a small footprint. They have been proven in many years of industrial use. Series SN 450... and SNT 450... have a plastic (PBT) housing and are available in many designs for direct and alternating voltage supply, with relay, PNP or analogue output. The STN 450... variants additionally feature an adjustable temperature monitoring, the variants with ...-VA or ...-VE have an adjustable time delay for the output. The compact devices LN 450... and LNZ 450... are suitable for use in air. They are available in the same variants as SN 450...

SCS 440.../SNS 450...

plug-in assembly

The measuring probes of the above-mentioned device series have been designed for assembly in cutting ring fittings. They are secured in the respective fitting with a union nut attached to the device. The connection is reliably sealed up to 100 bar. Various designs of the screw-in adapter allow the universal use of the flow sensor. The variants of the compact devices match the variants available for screw assembly.

"Inline" assembly

SDN 500.../SDN 552.../SDNC 500...

"Inline" assembly is through two opposing process connections at the device directly in a pipe or hose. The measuring tubes of the inline sensors are smooth on the inside and do not feature any pins protruding into the flow. They are characterised by short response times and a large detection range. Due to their compact design they can also be used where installation space is tight. For pulsating flows the inline sensors SDN... -DYN are suit-

able, which can detect very brief flow rates of the smallest volumes as soon as the flow starts. The SDN 500... are equipped with PNP, relay or analogue outputs.

Sensors of the series SDNC... have a space-saving cubic design and opposing process connections with a G1/4 thread. They have a wide detection range and are sometimes operated with a screw-on pre-adapter or a straight inlet section providing a favourable flow profile for the flow rate detection.

This device series has been pre-configured at factory or can be supplied flexibly parametrisable using an IO link. This design also offers a pulse output for simple volume detection.

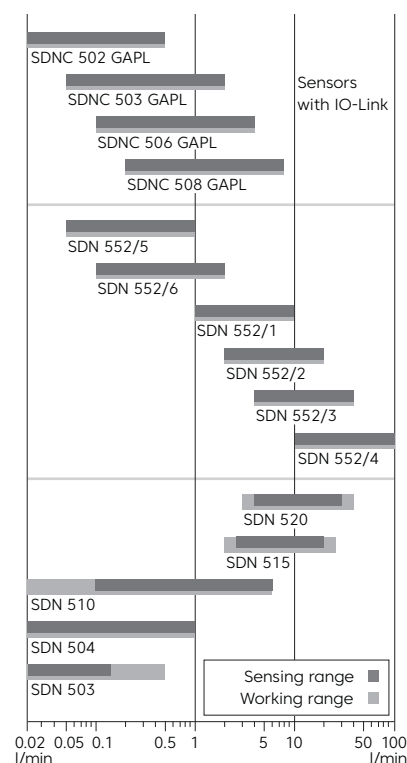

Flow ranges for EGE-Inline-Compact models

Flow Sensors

Technique & Application

Terminology

Detection range

The detection range of a probe or compact device indicates the flow velocities of the medium for which the probe can provide an analysable signal. If the medium is not specified, the details for water are applied. Because the different media have different thermal conductivity, the detection range as well as the temperature drift are also dependent of the respective medium.

At the upper and lower limit of the detection range, the temperature drift is higher. The detection range does not limit the maximum flow rate a sensor may be exposed to. Hence, a sensor with the upper detection limit set at 3 m/s can be operated at 10 m/s.

Operating range

The operating range characterises the section of the detection range for which the flow technology data have been specified. At the outer limits of the detection range these data are reduced. For sensors preconfigured at factory the working range represents the display or output range.

Nominal flow

For each sensor, data corresponding to its own nominal flow is measured. This is necessary because response characteristic curves of sensors are non-linear. Consequently the various sensor characteristics depend on the location of the chosen operating point on the curve. As a rule, the nominal flow-point is set in the middle of the portion of the (simple logarithmic representation of the characteristic) curve which appears to be linear. For this operating point, the following values may be defined: switching on and off times, stand by time, hysteresis and temperature response.

Supply voltage

The supply voltage is the voltage range within EGE Sensors function safely. For direct current supplies it must be ensured that the limits are maintained even including residual ripple.

Current consumption

The current consumption is the maximum value of the idle current I_0 which the flow monitor draws without load.

Switching current

The switching current indicates the maximum continuous current for the switching output of the device. For PNP outputs this value applies to an ambient temperature of 25 °C. At higher temperatures the maximum switching current is reduced. For devices with relays output the value is related to the utility category AC-12 or DC-12 in accordance with EN 60947-5-1.

Switching voltage

The switching voltage indicates the maximum voltage (including residual ripple) to be switched with the relay output.

Switching power

The switching power indicates the maximum power to be placed on the output relays.

Ambient temperature

The ambient temperature indicates the maximum and minimum permissible temperatures for the sensor.

Temperature of medium

The temperature range for which a sensor is rated. Applies to the medium to be monitored.

Temperature gradient

The temperature gradient defines the maximum temperature change of a medium per time unit which a sensor can track without malfunction. It is a measure for the quality of a flow sensor. The temperature gradient is determined at nominal data and with symmetrical installation of the measuring probe.

Start-up time

The start-up time is the period of time required by the flow detector to reach a stable state after the operating voltage has been switched on. Prerequisite is that the medium flows at the rated velocity and that the sensor has adapted to the temperature of the medium before switching the supply voltage on. The start-up time is prolonged in a static medium and reduced if the medium flows faster than the rated value.

Reaction time

The reaction time combines the switch-on and -off time. Switch-on time elapses from the beginning of the flow until the switching point set at the amplifier is reached. Switch-off time characteristic results for the flow sensors at pump shut-down. If the set switching point is close to maximum flow, the time elapsing between the pump shut-down and the indication of the flow decrease is short. If the switching point is close to the static value, the off-transition time will be long.

Compressive strength

Pressure resistance relates to the sensor casing. Up to the indicated maximum pressure, the sensor provides a steady signal in fluids and the casing suffers no damage. In case the application requires the use of threaded joints, these can have compressive strengths that are significantly lower than the data for the sensor, which must then be observed.

Protection class

The protection class indicates how well the equipment is protected against ingress of solids and water in accordance with EN 60529. For probes, the stated protection class always refers to the connection area. The area which is in contact with the medium always has IP 68.

Flow Sensors

Technique & Application

Terminology and Setting instructions

Switch-off delay

The variable time delay which can be set between 0 and 25 seconds becomes active during flow standstill (drop-out delay). If the medium ceases to flow and the amplifier display indicates this state, the relay contact is actuated only after the set delay. During the delay period the yellow LED lights up together with the red LED.

Cable break monitoring

Cable break monitoring shuts off the flow monitor output if no probe is connected or if the probe cable has been severed. In case of cable severing, "flow failure" signal is displayed. Cable break monitoring is available in the SKZ 400... The SKM 552... monitors each sensor cable for short circuit and cable break.

Switching output

General

- The output is active when the yellow LED is lit.
- Set the switching point with the potentiometer at the front of the device.
- Keep the flow rate and medium temperature stable during adjustment and wait for the temperature to equalise between the sensor and the medium.
- The flow rate must be within the detection rate of the measuring probe.
- If present, remove the protective screw M3 x 4 from the potentiometer opening for the duration of configuration.

Monitoring a flow limit for being exceeded

- Specify the flow rate or stop the flow and wait for the standby time.
- Turn the potentiometer screw clockwise until the yellow LED is lit.
- Turn the potentiometer screw counter-clockwise until the red LED is lit. The output is not active.

- Increase the flow rate. Monitor the LED displays and switching output. If the limit value is exceeded, the yellow LED is lit and the output is active. For a reliable monitoring the first green LED should also be lit after the flow commences. If necessary, change the adjustment.

This calibration is only possible if the flow rate of the medium is max. 70% of the limit value of the detection range of the selected measuring probe. If the red LED does not go out, the selected flow rate is too high or the hysteresis of the analysis device too great.

Monitoring a flow limit for being fallen below or standstill

- Turn the potentiometer screw counter-clockwise until the red LED is lit.
- Turn the potentiometer screw clockwise until the yellow and 2 green LEDs are lit. The switching output is active.
- Reduce the flow rate and monitor the LED displays and the switching output. If the yellow LED goes out, the output is deactivated.

The switching point for the flow rate is adjusted using one or two potentiometers. For flow rates which are higher than the detection limit of the measuring probe the loss or reduction of the flow rate is reported when the speed falls within the detection range of the measuring probe.

Limit temperature calibration

The desired value can be set (for devices with this option) with a potentiometer. The output switches when the set value is exceeded. At the same time the corresponding red LED at the device is also lit.

Time delay calibration

The desired value can be set with a potentiometer. In the SKM 522 the configuration takes place in the programming mode. The values are shown on a scale. If the red LED already indicates a loss of flow, the output remains switched until the time has expired. Then the yellow LED also goes out.

Automatic adjustment for SKM 522

Simultaneously pressing the two front buttons will open the programming menu. The automatic adjustment is selected with the FUNCTION button and started with the SELECT button. The adjustment is completed a few seconds later when at least the yellow LED lights up. Flow rate and temperature must be kept constant before and during the adjustment process. The function MAN. ADJUST can subsequently be used to manually modify the switching point.

LED functions flow

- Red:
- Flow has been interrupted or
- the flow rate has fallen below the specified value. The
- "flow" relay has dropped out.

- Yellow:
- The set flow rate has been
- reached, the "flow" relay
- pulls in.
-

- Green:
- The set flow rate has been
- exceeded. There is extra
- flow capacity.
-

LED temperature function

- Red:
- The set temperature value is reached and the "temperature" relay has pulled in.

LED time delay function

- Yellow and Red:
- Flow is below the set value. "Flow"
- relay remains pulled in until the
- set switch-off delay runs out.
-

Flow Sensors

Technique & Application

Setting instructions/Detection of microflow impulses

Analog output

Flow sensors with analog output supplies a current intensity which depends on the flow speed. The output current range is defined from 4 mA to 20 mA. The dependence between flow speed and output current is non-linear. The detection range is adjusted over two potentiometers: "Range" (↙) and "Adjust" (↗). The lowest value (>4 mA, 1st green LED) is set with the "Adjust" potentiometer at the smallest flow speed to be monitoring and the highest value (20 mA, 5th green LED) is set with the "Range" potentiometer at the highest flow speed to be monitored. The graph shows the characteristic lines obtained with the different settings.

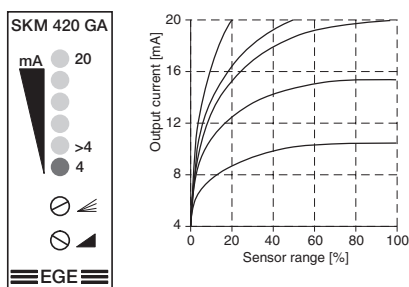

Detection of Microflow impulses

The SDN 50X/1 GSP-DYN is an in-line flow controller for monitoring pulsating flows. Unlike traditional monitoring devices which monitor compliance with a set limit in a continuous flow this particular flow controller detects when a liquid starts flowing. There are several parameters affecting the detection:

- the time it takes for the flow rate to change
- the time that the medium flows
- the time that the medium does not flow
- the magnitude at which the flow rate changes
- the specific properties of the medium

Optimal conditions for reliable detection are given in a highly thermally conductive medium which has not

moved for several seconds and is then passed through the sensor in a sudden burst for a short period of time. Nearly ideal flow pulses are provided by dispensing systems and lubrication systems which use piston pumps. These deliver fluid media in jerks and meet most of the requirements for a reliable pulse detection. The lower limit primarily depends on the volume that is delivered; this should not be less than 0.02 ml within a period of 0.1 s.

Impact of pulse time and duration of interruption

Furthermore, the dynamic pulse detection is affected by the duration of the pulse, i. e. the time the medium flows through the sensor, and the duration of the interruption, i. e. the time the medium does not move. As a general rule, the shorter the pulses the longer the interruption. For very low flow volumes this behaviour is even more pronounced than for high flow rates. In general, the shortest possible pulse duration is approx. 100 ms, while the shortest possible interruption is approx. 300 ms.

Impact of the medium's properties

All durations and volumes stated above depend on the heat transfer properties of the monitored medium. A medium with a relatively poor thermal conductivity, such as air, needs to flow through the sensor for a longer duration or with a higher speed. The shortest response times are achieved with water.

Temperature independent

Because of the dynamic measurement principle and irrespective of the medium's temperature, no specific adjustment is required for the pulse detection even after changing the medium.

Sensitivity

In order to suppress minor flow pulses which may occur during operation due to hose movements etc. there is a potentiometer which can be used to reduce the actuation sensitivity (also referred to as threshold). The sensitiv-

ity should generally only be set to such levels that still ensure reliable pulse detection.

Extending the switching signal

A convenient additional feature is the easily accessible potentiometer on the front panel of the device which allows extending the switching signal generated by the analysis unit to a value of up to 10 seconds. If another pulse is detected during this period the delay time is restarted without releasing the switching output.

Air inside the piping

Knowing the environmental conditions is particularly important for very low flow rates to ensure reliable pulse detection.

Trapped air inside the line connecting the valve and the nozzle has a damping effect on the pulse as the air buffer absorbs the surges of the pump and relaxes when the valve is closed. This may cause a continuous flow which can no longer be detected by a dynamic flow controller. In this case, it is recommended to use a monitoring device for continuous flows.

As a general rule, the flow controller should be installed near the valve. This largely eliminates the effects described above.

Detection in both directions

Reverse flows may occur during operation if, for example, the pressure completely drops during a dosing application, which the device may take for pulses. Ways to prevent such reverse flows include the installation of check valves and constructional measures.

Flow Sensors

Technique & Application

Detection of microflow impulses/Inline-Flow monitoring

Continuous switching signal

The adjustable output switching signal extension can be set to a time which is slightly above the duration of the pulse and the interruption. When a pulse is detected in this setting it will cause an output signal which is maintained until the extension time has elapsed. Any new pulse detected during this period will restart the interval. For the period of time during which the pulses are detected in regular succession the device will generate a continuous signal which is only reset if no additional flow pulses are detected.

Mounting position

As with all flow controllers the device should be mounted in a position which ensures that air can escape freely after the installation of the sensor. The preferred installation set-up would be a vertical pipe in which the medium moves upward.

Trapped air inside the medium

The sensor will detect an air pocket trapped inside the fluid as an interruption of flow which may cause a switching operation if the sensitivity is set high. However, such behaviour may be useful for certain applications.

Setting the sensitivity

After successful installation of the sensor, the power supply is switched on and the pulsating flow is started. The green LED on the device is lit. This indicates that the device is ready for operation. If the device does not immediately detect the pulses the signal extension should be set to minimum (turned counter-clockwise) and the sensitivity to maximum (turned clockwise). Once the pulse sequence falls within the detection limits the yellow LED will briefly flash each time a pulse is detected. It is now possible to slowly turn the sensitivity potentiometer counter-clockwise until the detection starts failing. When reaching this point, increase the sensitivity again until all pulses are detected.

Flow monitoring and measuring

The EGE-inline flow controllers with digital display monitor flow rates in the range of 0,05...100 l/min and display the flow rate digitally. They feature front panel buttons used to call functions and modify settings. The application area includes all areas of flow monitoring and measuring, in which a flow display is desired.

Series SDN 552/554 – thermal principle

The SDN 552/554 series is based on the thermodynamic principle, heat is created in a measuring pipe and absorbed by the passing medium. The dissipated heat quantity is a measurement for the flow speed. A microprocessor processes this data, calculates the flow rate quantity and displays the result in liters/minutes in a 3-digit, 7-segment display.

Page 1.53-1.63

Series SDV 652 – vortex principle

The flow measurement devices Series SDV 652 are based on the vortex principle. They are well suitable for applications, where a good linearity and larger measurement precision is necessary. They are insensitive to quick temperature changes and the reaction time of the device is below one second. The vortex principle allows a flow measurement without moving parts: Behind a bluff body in the flow, vortices are generated which are detected by the device and yield the flow velocity.

Page 1.64

Series SDI 852/853 – magnetic-inductive

The inline flow sensors SDI 852/853 offer a monitoring function as well as precise flow measurements in the range of 0...80 l / min with a measured error smaller than 2%. The flow rate is digitally depicted using a clear 3-digit, 7-segment display. The magnetic-inductive measuring system facilitates that this device is suitable for many different applications in the field of automating processes and workflows. Furthermore, a high degree of measuring accuracy is ensured. The magnetic-inductive measuring principle requires the electrical conductivity of the medium. Low limit values of 15 µS/cm for water or 10 µS/cm for other fluids still offer a broad function range. The combination of precise measuring system and small, compact design distinguishes the series SDI from other inline flow sensors. They are easy to install subsequently into existing configurations or offer a space-saving alternative for new constructions. Cooling and temperature control as well as metering circuits, for example in the field of water treatment, are precisely and accurately monitored. This is accomplished with a set point function as well as an analogue linear current and pulse output.

Page 1.65-1.66

Flow Sensors

Technique & Application

Inline-Flow monitoring/Ex area 

Installation

The inline flow sensors are installed "in-line" into a pipe line. The pipe may be connected directly with the compression tube fitting connection or with an adaptor SDA.... Threaded bushings are located in the bottom housing plate and are used to fasten the device to a support plate or other similar base. A mounting plate (optional accessory) may also be attached to the housing. This makes it possible to fasten the unit from the front.

Signal filter

The parameter for the signal filter allows inputting a value that determines the time interval in which the measuring signal is averaged. Inputs between 0 to 8 seconds are possible. A low value results in a very quick response; a high value results in a very steady display of the measured value. The filter is switched off when the setting is 0. Averaging has the same effect on display and outputs.

Access code

Protection against unauthorized access to the programming functions provides an access code. Without this number combination, only the currently saved values for the switching points and further parameters can be displayed.

Reference adjustment

The accuracy of the displayed flow rate quantity can be optimized with the CAL function using an exact reference flow rate meter. Here you have the option to modify the displayed flow rate value and adapt it to the reference value.

Medium preselection SDN 552/554

Besides water, a water-glycol mixture is also often used as a heat carrier in cooling systems. Due to the changed thermal properties of the fluid through the incorporation of glycol, the accuracy of the displayed flow rate value is affected and the limit values are also changed. To correct this effect, the devices of the SDN 552/554 type series have a function for selecting the measurement medium. Glycol fractions up to 30% can be entered. The

microprocessor working in the device then calculates the flow rate quantities considering the glycol fraction.

Applications

These devices are especially suitable for flow rate monitoring in cooling systems due to the greater functionality, as well as easy programming and installation.

These devices are characterized by short response times and robust display values, even if the medium is subject to large temperature fluctuations as to be found in welding technology in the automotive industry.

In the display, the flow rate value, which is continuously updated, is displayed in l/min. The person responsible for the plant or the machine has thus constantly the information on the available cooling performance. Industrial climate control units are often operated with a water-glycol mixture in the secondary cycle due to the danger of freezing. The glycol fraction can be programmed in the SDN menu in a couple of seconds to ensure a correct value is also displayed in the application.

Use in hazardous areas

The Ex measurement probes of the series 400 and the Ex-amplifiers SZAb... meet the basic health and safety requirements of Directive 2014/30/EC. Electrical boundary data, permissible temperature ranges as well as installation and connection instructions are specified in the operating instructions of Ex equipment. The permissible process pressure for the safe use of this devices in Ex atmospheres is 0.8...1.1 bar. The use of the measuring probes under different process pressures is the responsibility of the user. The specifications of the device must be observed. The permissible ambient temperature range is determined for each temperature class in the technical data. If there are additional regulations for the particular design regarding the installation, they must be observed as well.

Zone classification and categories

The frequency and duration of the occurrence of a hazardous atmosphere determines the zone classification.

Zone 0 / Category 1 (Gas)

Zone 0 is an area in which a potentially explosive atmosphere in the form of a mixture of air, combustible gases, vapours or fog continuously, for longer periods or frequently exists.

Zone 1 / Category 2 (Gas)

Zone 1 is an area in which a potentially explosive atmosphere as a mixture of air, combustible gases, vapours or fog can occasionally form in normal operation.

Zone 2 / Category 3 (Gas)

Zone 2 is an area in which a potentially explosive atmosphere as a mixture of air, combustible gases, vapours or fog can occur in normal operation.

Zone 20 / Category 1 (Dust)

Zone 20 is an area in which a potentially explosive atmosphere in the form of combustible particles suspended in air continuously, for longer periods or frequently exists.

Zone 21 / Category 2 (Dust)

Zone 21 is an area in which a potentially explosive atmosphere in the form of combustible particles suspended in air can occasionally form in normal operation.

Zone 22 / Category 3 (Dust)

Zone 22 is an area in which a potentially explosive atmosphere in the form of combustible particles suspended in air normally does not exist or only exists for a short period in normal operation.

Flow Sensors

Technique & Application

Ex area /Notes on safety applications

Specific conditions for use of flow sensor probes STS...

- Metallic process connection parts must be included in the local equipotential bonding.
- For equipment in the titanium housing, it must be ensured that there are no particles in the media flow that could cause an ignition hazard due to impact or friction.
- For EPL Ga/Gb applications and at risks by pendulum or vibration the respective parts of the flow sensor type STS... have to be secured effectively against these dangers.
- For EPL Ga/Gb applications the medium tangent materials of the flow sensor type STS have to be resistant to the media.
- For EPL Ga/Gb applications the whole device flow sensor type STS... shall be mounted in a way that allows an installation that results in a sufficient tight joint (IP 66 or IP 67) or a flameproof joint (IEC 60079-1) in the direction of the less endangered area.

A measurement probe may only be used in dust or gas protected hazardous areas, even when there are approvals for both areas. For use in hazardous areas for dusts the maximum surface temperature of the sensor is specified. For the hazardous area for gases the ambient temperatures of the temperature classes are given. On request, EGE delivers sensors with special dimensions and special materials as well as longer connection cables.

Ex marking

	A	B
II 1 G...	Zone 0	Zone 0
II 1/2 G...	Zone 0	Zone 1
II 2 G...	Zone 1	Zone 1
II 3 G...	Zone 2	Zone 2
II 1 D...	Zone 20	Zone 20
II 2 D...	Zone 21	Zone 21
II 3 D...	Zone 22	Zone 22

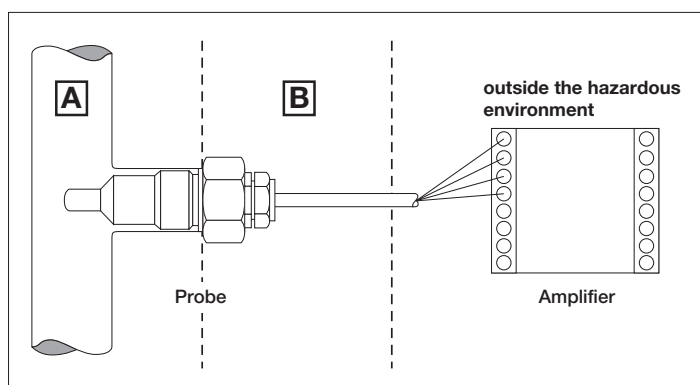

Notes on safety applications

The sensors are a standard component and not a safety device according to MD 2006/42/EC. For safety applications a detailed assessment of the possible use of the sensor accord. to EN ISO 13849 or an other applicable standard by the plant construction is necessary.

Flow Sensors

Technique & Application

IO-Link



IO-Link is an internationally standardised communication technology (IEC 61131-9) for the data exchange with sensors and actuators. IO-Link enables the continuous communication from the control down to the lowest field level to the sensor.

EGE is a member of the IO-Link group of companies organised within the PNO (Profibus user organisation). It develops the technology and supports the members and users in the integration of IO-Link enabled products.

The following description of the IO-Link technology explains the key terms and functions.

Further information is available on the homepage of the IO-Link consortium: www.io-link.com.

Benefits

Cost reduction

Parametrisable sensors and actuators with a standardised interface reduce the multitude of device types required and reduce complexity during procurement.

Innovative machine concepts

Only a continuous communication with each sensor and actuator opens up all functions of intelligent devices. This permits the implementation of innovative machine and plant concepts.

Short commissioning times

IO-Link communication runs over unshielded cables and uses common industry connectors. The installation location can be optimised and the sensor later parametrised within the system. The complete parameter set can be stored in digital form and transmitted freely to additional devices.

Productivity

IO-Link devices automatically identify and parametrise themselves when changed (data storage). This simplifies the replacement of faulty components and reduces repair-related downtimes of machines and plant.

Maintenance

Intelligent IO-Link devices can be uniquely identified in the system, offer functions for self-diagnosis and supply data for the analysis of the system functionality. This permits novel preventative repair and maintenance concepts.

Parametrisation

IO-Link enabled sensors can comfortably be parametrised with a PC/ Notebook, an IO-Link master and the corresponding software and can then be used as conventional sensors with switching and analogue output (SIO mode). Alternative their use is also possible as IO-Link devices which supply the sensor signals as process data to a control.

System overview

An IO-Link system generally consists of the following components:

- IO-Link master
- IO-Link device (sensor/actuator)
- Unshielded cable
- Software for project planning and parametrisation of IO-Link devices

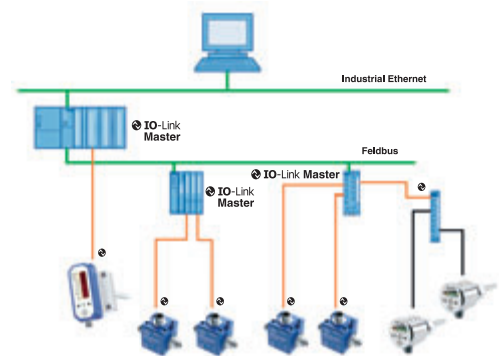

The IO-Link master provides the connection between the IO-Link sensor/ actuator and the automation system. As part of a peripheral system the IO-Link master is either coupled directly to the PLC in the control cabinet or installed as remote I/O component with field bus connection in the machine or plant. Such masters have several channels which can each be connected to a device with IO-Link functionality.

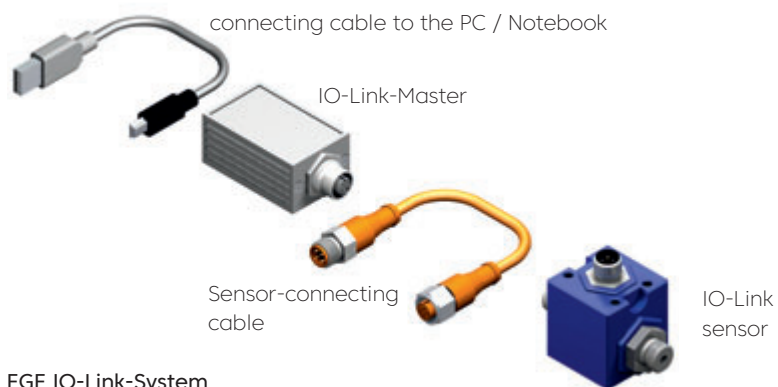

EGE IO-Link-System

Flow Sensors

Technique & Application

IO-Link

IO-Link interface

IO-Link is a serial bidirectional point-to-point communication for the signal transmission and energy supply.

Connection technology in IP 65/IP 67

For the connection technology in IP 65 / 67 e.g. M12 plug connectors have been defined. Sensors normally feature a 4 pin connector and actuators a 5 pin connector.

IO-Link masters normally feature a 5 pin M12 socket.

The connection assignment has been specified in IEC 60974-5-2 as follows:

- Pin 1/L+ (BN): 24 V DC (IO-Link-specification: 18...30 V DC)
- Pin 3/L- (BU): 0 V
- Pin 4/C/Q (BK): Switching (Q)- and communication (C) line

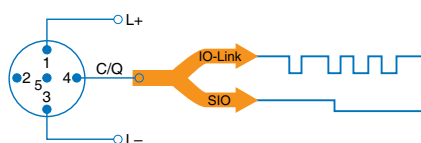

Connection type A

In type A the functional assignment for pin 2 and pin 5 is not defined by the IO-Link specification. The manufacturer can use these freely for additional output and input functions.

EGE uses pin 2 for an additional switching output, a 4...20 mA output or as signal input.

Connection cable

The connection cable of an IO-Link device to the master should according to the IO-Link specification not exceed a length of 20 m. An unshielded standard cable is sufficient.

IO-Link-communication

Operating modes

The port (pin 4 / C/Q) of an IO-Link master can be operated in the following operating modes:

- IO-Link: Data transfer between device and master
- DI (digital input): The binary output state of the connected device is processed (the sensor output supplies a switching signal).
- DQ (digital output): At the output the corresponding high or low level is present (an actuator is actuated).
- Deactivated: No use has been assigned to the port.

Starting the I/O-Link-communication

If the operating mode IO-Link is assigned to the port of an IO-Link master, the communication starts. The IO-Link master supplies a wake-up pulse and waits for the response of the IO-Link partner. After successfully establishing a connection, the master determines the data transmission rate of the device and starts the communication.

Transmission speed

The IO-Link specification V1.1 specifies three data transmission rates:

- COM 1: 4.8 kBd
- COM 2: 38.4 kBd
- COM 3: 230.4 kBd

An IO-Link device only supports one of the defined data transmission rates. An IO-Link master according to specification V1.1 supports all data transmission rates and automatically adjusts to the data transmission rate supported by the device.

Response time

The response time of an IO-Link system depends on the minimum cycle time of the device and the processing speed of the master. The device description file IODD includes a value for the minimum cycle time.

Transmission quality

The IO-Link communication utilises the 24 V level of the switching output for the transmission and is therefore highly interference-resistant. If the IO-Link software detects an error in the data transmission, this is repeated. Only after three consecutive failed attempts is the connection terminated. This termination is reported to the higher level control without delay as an error message.

Flow Sensors

Technique & Application

IO-Link

Data types

Generally, four data types are available:

- Process data: Cyclic data
- Value status: Cyclic data
- Device data: Acyclic data
- Events: Acyclic data

Process data and value status

Process data and their value status are transmitted cyclically in a data telegram. The process data lengths has been defined with 0 to 32 bytes for each device in its specification by the manufacturer. The value status indicates whether the process data are value or invalid.

Device data

Device data may be parameters, identification data and diagnostic information. They are exchanged acyclically between the master and the device.

Events

If a previously defined event occurs in the device, the occurrence is reported to the master. The master then requests further information from the device and forwards the messages to the control. Events may be error messages and warnings. The IO-Link master can also transmit its own error messages and status data to the control.

The transmission of parameters or events is unaffected by the cyclical transmission of the process data.

Device profiles

Access from application programs to a device is standardised with IO-Link device profiles.

The device profiles define the data structure and content and the basic functionality. Different IO-Link devices are thus provided with a uniform user perspective and an identical program access by the control.

Smart sensor profile

In the IO-Link specification the "smart sensor profile" has currently been defined. It is particularly suited for measuring sensors, because in addition to the switching points measured values are also transmitted.

IODD device description file

The manufacturer provides for his IO-Link product an IODD (Input Output Device Description) in the form of XML files and images in digital form. The specified uniform structure of these files ensures the manufacturer-independent universal handling of the data. The IODD contain information about:

- Communication properties
- Device parameters with value ranges and default values
- Identification, process and diagnostic data
- Device data
- Text descriptions
- Device images
- Manufacturer logo

For devices which in addition to IO-Link version 1.0 also support version 1.1 there exist accordingly two different IODD versions.

IO-Link configuration tool

Software provided by the master manufacturer is required to configure an IO-Link system. This software uses the IODD for the communication and parametrisation of an IO-Link device. If multiple masters are used in control systems, the software has additional tasks:

- Assignment of the devices to the ports of the master
- Address allocation within the address range of the master

Flow Sensors

Technique & Application

IO-Link

EGE-Products with IO-Link

EGE continuously expands its portfolio with sensors which include the IO-Link functionality. These can be integrated directly via the IO-Link interface in a control system and parametrised comfortably via this connection. As with all standard components, customer-specific special designs are also possible within the framework of the IO-Link specification for products with IO-Link interface.

IO-Link Master



With the IO-Link master the easy parametrisation of IO-Link enabled sensors is possible. The matching configuration software is available as download from www.iq2.development and can be installed on a PC or Notebook. The set includes in addition to the master and power supply also an M12 connection cable to the sensor and a USB cable for connection to the PC.

IO-Link-USB-Master-Set Z01216

Flow rate measurement and monitoring with SDNC 500 GAPL/ GANPL



for water-based media, linearized:

SDNC 502 GAPL	0.020...0.500 l/min	P11381
SDNC 503 GAPL	0.05...2.00 l/min	P11375
SDNC 506 GAPL	0.10...4.00 l/min	P11377
SDNC 508 GAPL	0.20...8.00 l/min	P11379

for water/glycol/oil, non linear:

SDNC 503 GANPL	0.0...appr. 6,0 l/min	P11376
SDNC 506 GANPL	0.0...appr. 15.0 l/min	P11378
SDNC 508 GANPL	0.0...appr. 30.0 l/min	P11380

SDNC 500 sensors with IO-Link interface are the smart solution for process monitoring. They can record the flow speed and temperature in fluid mediums. To do so, there is a configuration software which configures the sensors via an IO-Link/USB master. The ... GAPL models provide flow data for liquid mediums as a linear output signal. The detection range of sensors suitable for all liquid media can be freely configured. Their output signal is not linear.

Functions/parameters

- Limit value and range monitoring for flow rate and temperature
- Adjustable delay for the switching signal
- Analog output scalable for flow rate or temperature
- Pulse output for flow rate
- Logical linking of flow rate and temperature monitoring
- Teach commands for determining the limit and range values
- TAG identification programmable
- Available in the SIO mode analog and switching output

The flow rate sensors have a G1/4 process connection and can be easily integrated with hoses or pipe connectors in pipes. A special flow adapter shapes the flow profile and ensures a stable signal for the SDNC 502/503/506 GAPL. In the SDNC 508 GAPL a straight inlet section of 100 mm is sufficient to achieve the specifications. The measuring range of the ...GANPL variants can be adapted to almost all media. A non-linear signal path results. The robust construction makes the sensors not sensitive to moisture and vibrations.

Compressed air consumption measurement with LDN, LDV and LDS

The compressed air sensors LDN 1009, LDV 1025/1040 and LDS 1000 detect the flow rate, the temperature and the pressure (not LDN 1009) in compressed air networks. They display the current air flow rate of a connected tool or system in an easy-to-read display and respond quickly to any changes in flow speed. At the same time the sensors also act as volume meters and measure the air consumption in the units standard litre and standard cubic metre.



The parametrisation of the sensors is via the IO-Link interface or the buttons on the front panel. Its 6-digit display shows the measurement values which can be sent as process data to an SPS via the IO Link connection. In the IOS mode the user can use the configured analogue and switching outputs.

Flow Sensors

Technique & Application

IO-Link

Functions/parameters

- Resettable compressed air consumption meter
- Limit value and range monitoring for all variables
- Adjustable delay of the switching signal
- Scalable analog output for all variables
- Selectable variable for display
- Selectable measuring unit for flow rate and consumption
- 24h average / max and min value readable for all variables
- Configurable outputs (PNP/NPN-NO/NC)
- Adjustable reference values for standard pressure and standard temperature
- TAG ID programmable and readable on device
- Modification counter (changes to the device configuration)
- In the SIO mode analogue and switching output or two switching outputs available

LDN 1009 GAPL



LDN 1009 GAPL G1/4 • 15 Nm³/h
P11373

The functional principle of the compressed air sensor is calorimetric. Heat is removed from a sensor element by passing air and results in a temperature reduction. The amount of reduction is determined by the air mass and results in an output signal proportional to the mass flow. No pressure or temperature compensation is required for the medium state. According to factory configuration the flow rate is displayed directly in standard litres or standard cubic metres. The standard condi-

tions for pressure and temperature can be adjusted in the application.

The sensor is inserted inline into the pipe line. The lengths for run-in and run-out distances required result from pipe routes and any existing controls and instruments upstream of the sensor. For the operation of the compressed air meters the air must be free from oil, filtered and dehumidified in accordance with class 1.4.1 as per ISO 8573-1.

LDV 1025/LDV 1040



LDV 1025 GAPL G1 • 420 Nm³/h
P11382
LDV 1040 GAPL G1 1/2 • 750 Nm³/h
P11383

In these sensors the air flow causes in the area of the reduced diameter a vacuum compared to the inlet pressure. This pressure difference is a measure for the flow rate. The influence of the absolute pressure and the air temperature on the flow volume is taken into account by integrated measuring elements. The sensors are installed "inline" in the pipe. No special measures for dehumidification and filtering of the compressed air are required. To achieve the specified deviations, straight inlet and outlet sections without steps must be provided.

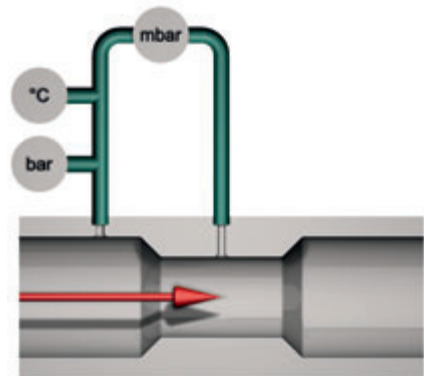

Outside the usual pressure ranges the consumption sensors also operate in the low pressure range with a limited functional scope. The optimum ranges of application (green area) for the variants LDV 1025 and LDV 1040 are shown in the diagrams below.

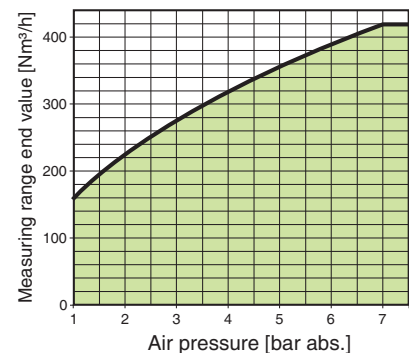

Working range LDV 1025 GAPL

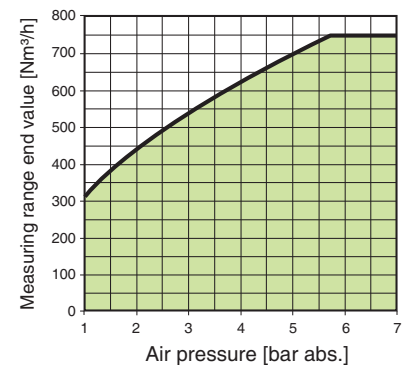

Working range LDV 1040 GAPL

Flow Sensors

Technique & Application

IO-Link

LDS 1000

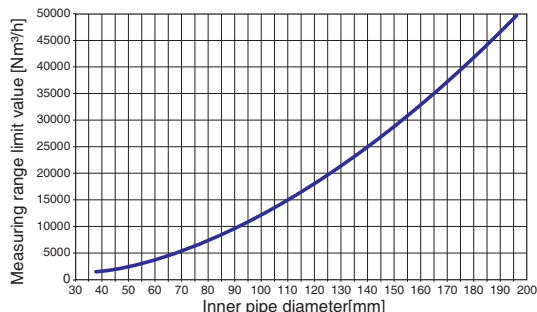

LDS 1000 GAPL usabile up to $d = 200$ mm
P11388

The LDS 1000 is used as immersion sensor in compressed air lines from DN 40. By entering the internal pipe diameter the measuring range limit value for the sensor is determined and the flow rate or air consumption indicated on the display. The measuring range related to the diameter is shown in the diagram below. Via the IO-Link interface the sensor supplies the flow rate data as a percentage value of the measuring range limit value. The limit value can be read as device parameter with the parametrisation software.

The sensor is installed with a cutting ring fitting in the pipe. The lengths for run-in and run-out distances required result from pipe routes and any existing controls and instruments upstream of the sensor.

Outside the usual pressure ranges the sensor also operates in the low pressure range with a limited application scope. The optimum functional range (green area) is shown in the diagram.

The air flow causes at the measuring point of this sensor which is overflow an overpressure compared to the downstream measuring aperture. This pressure difference is a measure for the flow rate. The influence of the absolute pressure and the air temperature on the flow volume is calculated by integrated measuring elements and taken into account when analysing the pressure difference.

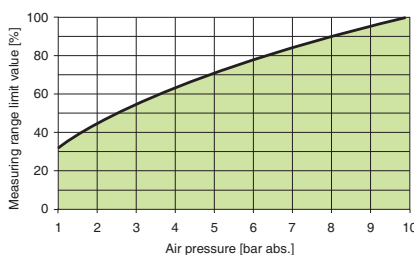

Working range LDS 1000 GAPL

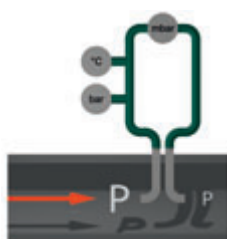



Compact models DC-PNP | Screw-in mounting

DC 24 V

Robust stainless steel housing

- G1/4 thread
- G1/2 thread
- NPT 1/2 thread



Design	G1/4	G1/2			NPT1/2
Dimensions					
Detection range [cm/s]	water 1...150 / oil 3...300				
Output	 PNP				
Sensor length L [mm]	25	31	48	80	120
Thread	G1/4	G1/2	G1/2	G1/2	G1/2
ID-No.	P11064*	P10521*	P10523*	P10525*	P10526*
Type	SC 440/5-A4-GSP	SC 440-A4-GSP	SC 440/1-A4-GSP	SC 440/2-A4-GSP	SC 440/3-A4-GSP
Supply voltage [V]	24 DC ±20%				
Current consumption [mA]	< 70				
Switching current [mA]	< 400 (20 °C)				
Ambient temperature [°C]	-20...+80				
Medium temperature [°C]	-20...+80				
Temperature gradient [K/min]	250 (> 60 cm/s)				
Start-up time typ. [s]	8 (2...15)				
Reaction time typ. [s]	2 (1...13)				
Compressive strength [bar]	100				
Sensor material	AISI 316 Ti • different materials on request				
Housing material	AISI 316 Ti / AISI 303				
Display flow	LED-array				
Protection [EN 60529]	IP 67				
Connection	M12 connector				
* US LISTED E304328					
Accessories	connecting cable type SLG 3-2, SLG 3-5, SLW 3-2, SLW 3-5, see page 1.114				



Compact models DC-PNP | Plug-in installation

DC 24 V

Robust stainless steel housing

Connection thread M18x1.5

Can be used universally with an adapter



Design M18x1.5

Dimensions

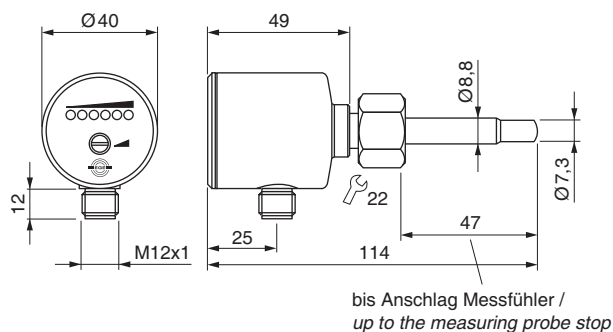

Detection range	[cm/s]	water 1...150 / oil 3...300
Output		PNP
Sensor length L	[mm]	47
Thread fixing nut		M18x1.5
ID-No.		P11352
Type		SCS 440-A4-GSP
Supply voltage	[V]	24 DC ±20%
Current consumption	[mA]	< 70
Switching current	[mA]	< 400 (20 °C)
Ambient temperature	[°C]	-20...+80
Medium temperature	[°C]	-20...+80
Temperature gradient	[K/min]	250 (>60 cm/s)
Start-up time typ.	[s]	8 (2...15)
Reaction time typ.	[s]	2 (1...13)
Compressive strength	[bar]	100
Material		housing: AISI 316 L sensor: AISI 316 Ti
O-Ring-Material		FPM
Display flow		LED-array
Protection	[EN 60529]	IP 67
Connection		M12 connector

* US LISTED
E304328

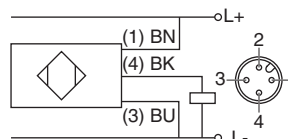

Accessories connecting cable type SLG, SLW (page 1.114), screw-in adapter SDA-SCS-... (page 1.118)



Compact models AC/DC

AC 230 V • AC 115 V • DC 24 V

PNP output • Relay output

Connection thread M18x1.5

Can be used universally with an adapter



Design	M18x1.5			
Dimensions				
Detection range [cm/s]	water 1...150 / oil 3...300			
Output	 PNP		 Relay	
Sensor length L [mm]	47	47	47	47
Connection thread G	M18x1.5	M18x1.5	M18x1.5	M18x1.5
ID-No.	P11360*	P11362*	P11364*	P11365*
Type	SNS 450-A4-GSP-S	SNS 450-A4-GR	SNS 450-A4-WR1	SNS 450-A4-WR2
Supply voltage [V]	24 DC ±20%	24 DC ±20%	115 AC ±10%	230 AC ±10%
Current consumption [mA]	< 60	< 100	< 65	< 35
Switching voltage max. [V]	-	250 AC / 60 DC	250 AC / 60 DC	250 AC / 60 DC
Switching current max. [A]	0.4 (20°C)	4 AC / 4 DC	4 AC / 4 DC	4 AC / 4 DC
Switching power max.	-	1000 VA / 60 W	1000 VA / 60 W	1000 VA / 60 W
Ambient temperature [°C]	-20...+70			
Medium temperature [°C]	-20...+80			
Temperature gradient [K/min]	250			
Start-up time typ. [s]	8 (2...15)			
Reaction time typ. [s]	2 (1...13)			
Compressive strength [bar]	100			
Sensor material	AISI 316 Ti			
Housing material	PBT			
Display flow	LED array			
Protection [EN 60529]	IP 67			
Connection	M12 connector	2 m PVC-cable 5x0.5 mm ²		
* US LISTED E304328				
Accessories	connecting cable type SLG, SLW (page 1.114), screw-in adapter SDA-SCS-... (page 1.118)			



Compact models DC-PNP | Screw-in mounting

DC 24 V

PNP output

G1/2 thread



Design	G1/2 • L= 31 mm		G1/2 • L= 48 mm	
Dimensions				
Detection range [cm/s]	water 1...150 / oil 3...300			
Output				
Sensor length L [mm]	31	31	48	48
Thread	G1/2	G1/2	G1/2	G1/2
ID-No.	P11241*	P11161*	P11228*	P11162*
Type	SN 450-A4-GSP	SN 450-A4-GSP-S	SN 450/1-A4-GSP	SN 450/1-A4-GSP-S
Supply voltage [V]	24 DC ±20%			
Current consumption [mA]	< 60			
Switching current [mA]	< 400 (20 °C)			
Ambient temperature [°C]	-20...+70			
Medium temperature [°C]	-20...+80			
Temperature gradient [K/min]	250 (> 60 cm/s)			
Start-up time typ. [s]	8 (2...15)			
Reaction time typ. [s]	2 (1...13)			
Compressive strength [bar]	100			
Sensor material	AISI 316 Ti • different materials on request			
Housing material	PBT			
Display flow	LED-array			
Protection [EN 60529]	IP 67			
Connection	2 m PVC-cable 3x0.5 mm ²	M12 connector	2 m PVC-cable 3x0.5 mm ²	M12 connector
* US LISTED E304328				
Accessories	connecting cable type SLG 3-2, SLG 3-5, SLW 3-2, SLW 3-5, see page 1.114			



Compact models DC-Relay | Screw-in mounting

DC 24 V

Relay output

G1/2 thread



Design	G1/2 • L= 31 mm/48 mm		G1/2 • L= 31 mm/48 mm	
Dimensions				
Detection range [cm/s]	water 1...150 / oil 3...300			
Output	Relay		Relay	
Sensor length L [mm]	31	48	31	48
Thread	G1/2	G1/2	G1/2	G1/2
ID-No.	P11115	P11078	P11116	P11086
Type	SN 450-A4-GR	SN 450/1-A4-GR	SN 450-A4-GRS	SN 450/1-A4-GRS
Supply voltage [V]	24 DC ±20%			
Current consumption [mA]	< 80			
switching voltage max. [V]	250 AC / 60 DC		30 AC / 36 DC	
Switching current max. [mA]	4 A AC / 4 A DC		1 A AC / 1 A DC	
Switching power max.	1000 VA / 60 W		-	
Ambient temperature [°C]	-20...+70			
Medium temperature [°C]	-20...+80			
Temperature gradient [K/min]	250 (> 60 cm/s)			
Start-up typ. [s]	8 (2...15)			
Reaction time typ. [s]	2 (1...13)			
Compressive strength [bar]	100			
Sensor material	AISI 316 Ti • different materials on request			
Housing material	PBT			
Display flow	LED-array			
Protection [EN 60529]	IP 67			
Connection	2 m PVC-cable 5x0.5 mm ²		M12 connector	
Accessories	connecting cable type SLG 4-2, SLG 4-5, SLW 4-2, SLW 4-5, see page 1.114			

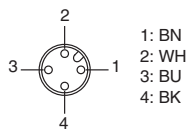



Compact models AC-Relay | Screw-in mounting

AC 230 V • AC 115 V

Relay output

G1/2 thread



Design	G1/2 • L= 31 mm		G1/2 • L= 48 mm	
Dimensions				
Detection range [cm/s]	water 1...150 / oil 3...300			
Output	 Relay			
Sensor length L [mm]	31	31	48	48
Thread	G1/2	G1/2	G1/2	G1/2
ID-No.	P11113	P11114	P11074	P11076
Type	SN 450-A4-WR1	SN 450-A4-WR2	SN 450/1-A4-WR1	SN 450/1-A4-WR2
Supply voltage [V]	115 AC ±15%	230 AC ±15%	115 AC ±15%	230 AC ±15%
Current consumption [mA]	< 60	< 30	< 60	< 30
Switching voltage max. [V]	250 AC / 60 DC			
Switching current max. [mA]	4 A AC / 4 A DC			
Switching power max.	1000 VA / 60 W			
Ambient temperature [°C]	-20...+70			
Medium temperature [°C]	-20...+80			
Temperature gradient [K/min]	250 (> 60 cm/s)			
Start-up time typ. [s]	8 (2...15)			
Reaction time typ. [s]	2 (1...13)			
Compressive strength [bar]	100			
Sensor material	AISI 316 Ti • different materials on request			
Housing material	PBT			
Display flow	LED-array			
Protection [EN 60529]	IP 67			
Connection	2 m PVC-cable 5x0.5 mm ²			



Compact models AC/DC | Extra long

AC 230 V • AC 115 V • DC 24 V

Relay output

G1/2 thread



Design	G1/2 • L= 80 mm			G1/2 • L= 120 mm		
Dimensions						
Detection range [cm/s]	water 1...150 / oil 3...300					
Output	 Relay					
Sensor length L [mm]	80	80	80	120	120	120
Thread	G1/2	G1/2	G1/2	G1/2	G1/2	G1/2
ID-No.	P11079	P11080	P11081	P11082	P11083	P11084
Type	SN 450/2-A4-WR1	SN 450/2-A4-WR2	SN 450/2-A4-GR	SN 450/3-A4-WR1	SN 450/3-A4-WR2	SN 450/3-A4-GR
Supply voltage [V]	115 AC ±15%	230 AC ±15%	24 DC ±20%	115 AC ±15%	230 AC ±15%	24 DC ±20%
Current consumption [mA]	< 60	< 30	< 80	< 60	< 30	< 80
Switching voltage max. [V]	250 AC / 60 DC					
Switching current max. [mA]	4 A AC / 4 A DC					
Switching power max.	1000 VA / 60 W					
Ambient temperature [°C]	-20...+70					
Medium temperature [°C]	-20...+80					
Temperature gradient [K/min]	250 (> 60 cm/s)					
Start-up time typ. [s]	8 (2...15)					
Reaction time typ. [s]	2 (1...13)					
Compressive strength [bar]	100					
Sensor material	AISI 316 Ti • different materials on request					
Housing material	PBT					
Display flow	LED-array					
Protection [EN 60529]	IP 67					
Connection	2 m PVC-cable 5x0.5 mm ²					



Compact models DC-Analog | Plug-in installation

DC 24 V

Analog output 4...20 mA

Connection thread M18x1,5

Can be used universally with an adapter



Design M18x1.5

Dimensions

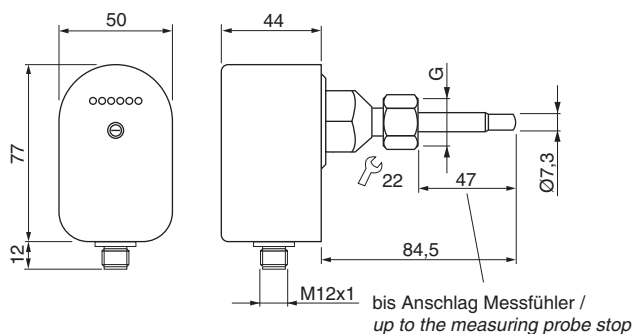

Detection range [cm/s]			
Water	5...150	5...300	1...150
Oil	-	-	3...300
Output	 4...20 mA		
Sensor length L	47	47	47
Connection thread G	M18x1.5	M18x1.5	M18x1.5
ID-No.	P11357*	P11358*	P11359*
Type	SNS 450 GA	SNS 450 GA-3M	SNS 450 GAN-S
Supply voltage [V]	24 DC ±10%		
Current consumption [mA]	<100		
Current output [mA]	4...20, linear	4...20, linear	4...20, non linear
Load RL [Ω]	200...500		
Ambient temperature [°C]	-20...+70		
Medium temperature [°C]	-20...+80		
Start-up time typ. [s]	8...60		
Reaction time typ. [s]	3		
Compressive strength [bar]	100		
Sensor material	AISI 316 Ti		
Housing material	PBT		
Display flow	LED-array		
Protection [EN 60529]	IP 67		
Connection	M12 connector		
* US LISTED E304328			
Accessories	connecting cable type SLG, SLW (page 1.114), screw-in adapter SDA-SCS-... (page 1.118)		



Compact models DC-2x PNP | Screw-in mounting

DC 24 V

PNP output

G1/2 thread

Two independent switching points



Design **G1/2 • L= 31 mm**

Dimensions

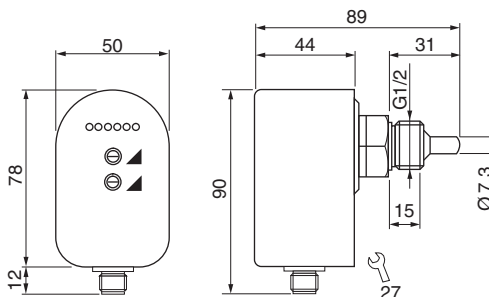

Detection range	[cm/s]	water 1...150 / oil 3...300
Output		2x PNP
Sensor length L	[mm]	31
Thread		G1/2
ID-No.		P11264*
Type		SN 450 GPP
Supply voltage	[V]	24 DC ±20%
Current consumption	[mA]	< 60
Switching current max.	[mA]	200 (20 °C) each output
Ambient temperature	[°C]	-20...+60
Medium temperature	[°C]	-20...+80
Temperature gradient	[K/min]	250 (>60 cm/s)
Start-up time typ.	[s]	8 (2...15)
Reaction time typ.	[s]	2 (1...13)
Compressive strength	[bar]	100
Sensor material		AISI 316 Ti • different materials on request
Housing material		PBT
Display flow		LED-array
Protection	[EN 60529]	IP 67
Connection		M12 connector

* US LISTED
E304328

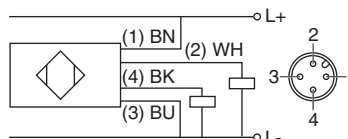

Accessories connecting cable type SLG 4-2 (Z00445), see page 1.114



Compact models DC | with temperature control

DC 24 V
PNP output
G1/2 thread



Design	G1/2 • L= 31 mm		G1/2 • L= 48 mm	
Dimensions				
Detection range [cm/s]	water 1...150 / oil 3...300			
Output	 2x PNP			
Sensor length L [mm]	31	31	48	48
Temperature [°C]	0...+80	0...+80	0...+80	0...+80
ID-No.	P11218*	P11219*	P11224*	P11225*
Type	SNT 450-A4-GSP	SNT 450-A4-GSP-S	SNT 450/1-A4-GSP	SNT 450/1-A4-GSP-S
Supply voltage [V]	24 DC ±20%			
Current consumption [mA]	< 60			
Switching current max. [mA]	200 (20 °C) each output			
Ambient temperature [°C]	-20...+70			
Medium temperature [°C]	-20...+80			
Temperature gradient [K/min]	250(> 60 cm/s)			
Start-up time typ. [s]	8 (2...15)			
Reaction time typ. [s]	2 (1...13)			
Compressive strength [bar]	100			
Sensor material	AISI 316 Ti • different materials on request			
Housing material	PBT			
Display flow	LED-array			
Protection [EN 60529]	IP 65			
Connection	2 m PVC-cable 4x0.5 mm ²	M12 connector	2 m PVC-cable 4x0.5 mm ²	M12 connector
* US LISTED E304328				
Accessories	connecting cable type SLG 4-2, SLG 4-5, SLW 4-2, SLW 4-5, see page 1.114			



Compact models DC | with temperature control

DC 24 V

Relay output

G1/2 thread



Design	G1/2 • L= 31 mm		G1/2 • L= 48 mm	
Dimensions				
Detection range [cm/s]	water 1...150 / oil 3...300			
Output	 Relay			
Sensor length L [mm]	31	31	48	48
Temperature [°C]	0...+80	0...+80	0...+80	0...+80
ID-No.	P11216	P11217	P11222	P11223
Type	SNT 450-A4-GR	SNT 450-A4-GR-S	SNT 450/1-A4-GR	SNT 450/1-A4-GR-S
Supply voltage [V]	24 DC ±20%	24 DC ±20%	24 DC ±20%	24 DC ±20%
Current consumption [mA]	< 80	< 80	< 80	< 80
Switching voltage max. [V]	250 AC / 60 DC	30 AC / 36 DC	250 AC / 60 DC	30 AC / 36 DC
Switching current max. [mA]	2A AC / 2A DC	1A AC / 1A DC	2A AC / 2A DC	1A AC / 1A DC
Switching power max.	500 VA / 60 W	-	500 VA / 60 W	-
Ambient temperature [°C]	-20...+70			
Medium temperature [°C]	-20...+80			
Temperature gradient [K/min]	250 (> 60 cm/s)			
Start-up time typ. [s]	8 (2...15)			
Reaction time typ. [s]	2 (1...13)			
Compressive strength [bar]	100			
Sensor material	AISI 316 Ti • different materials on request			
Housing material	PBT			
Display flow	LED-array			
Protection [EN 60529]	IP 65			
Connection	2 m PVC-cable 6x0.5 mm ²	M12 connector	2 m PVC-cable 6x0.5 mm ²	M12 connector
Accessories	connecting cable type SLG 5-2, SLW 5-2, see page 1.114			



Compact models AC | with temperature control

AC 230 V • AC 115 V

Relay output

G1/2 thread



Design	G1/2 • L= 31 mm		G1/2 • L= 48 mm		
Dimensions					
Detection range	[cm/s] water 1...150 / oil 3...300				
Output	 Relay				
Sensor length L	[mm]	31	31	48	48
Temperature	[°C]	0...+80	0...+80	0...+80	0...+80
ID-No.		P11214	P11215	P11220	P11221
Type		SNT 450-A4-WR1	SNT 450-A4-WR2	SNT 450/1-A4-WR1	SNT 450/1-A4-WR2
Supply voltage	[V]	115 AC ±15%	230 AC ±15%	115 AC ±15%	230 AC ±15%
Current consumption	[mA]	< 60	< 30	< 60	< 30
Switching voltage max.	[V]	250 AC / 60 DC			
Switching current max.	[A]	2 AC / 2 DC			
Switching power max.		500 VA / 60 W			
Ambient temperature	[°C]	-20...+70			
Medium temperature	[°C]	-20...+80			
Temperature gradient	[K/min]	250 (> 60 cm/s)			
Start-up time typ.	[s]	8 (2...15)			
Reaction time typ.	[s]	2 (1...13)			
Compressive strength	[bar]	100			
Sensor material		AISI 316 Ti • different materials on request			
Housing material		PBT			
Display flow		LED-array			
Protection	[EN 60529]	IP 65			
Connection		2 m PVC-cable 6x0.5 mm ²			



Compact models AC/DC | Turn on/off delay

AC 230 V • DC 24 V

Relay output

G1/2 thread



Design	Turn on delay		Turn off delay	
Dimensions				
Detection range [cm/s]	water 1...150 / oil 3...300			
Output	 Relay			
ID-No.	P11234	P11233	P11231	
Type	SN 450/1 GR-VE	SN 450/1 GR-VA	SN 450/1 WR2-VA	
Turn on delay [s]	0...25	-	-	
Turn off delay [s]	-	0...25	0...25	
Supply voltage [V]	24 DC ±20%	24 DC ±20%	230 AC ±15%	
Current consumption [mA]	< 80	< 80	< 30	
Switching voltage max. [V]	250 AC / 60 DC			
Switching current max. [A]	2 AC / 2 DC			
Switching power max.	500 VA / 60 W			
Ambient temperature [°C]	-20...+70			
Medium temperature [°C]	-20...+80			
Temperature gradient [K/min]	250 (> 60 cm/s)			
Start-up time typ. [s]	8 (2...15)			
Reaction time typ. [s]	2 (1...13)			
Compressive strength [bar]	100			
Sensor material	AISI 316 Ti • different materials on request			
Housing material	PBT			
Display flow	LED-array			
Protection [EN 60529]	IP 65			
Connection	2 m PVC-cable, 5x0.5 mm ²			