

















- (A) 20.8m
68ft 6in 
- (B) 18.8m
62ft 
- (C) 13m
42ft 8in 
- 250kg
550lbs 
- 1.8m x 0.8m
5ft 11in x 2ft 8in 
- 150° 
- 160° 
- (D) 2.18m
7ft 2in 
- (F) 2.27m
7ft 5in 
- (H) 5.47m
17ft 11in 
- (J) 6.62m
22ft 
- 6km/h
3.7mph 
- 3.89m
12ft 9in 
- 45°
24° 
- 6680kg
14730lbs 



SiOPS® toughcage Niftylink® Gen² Hybrid

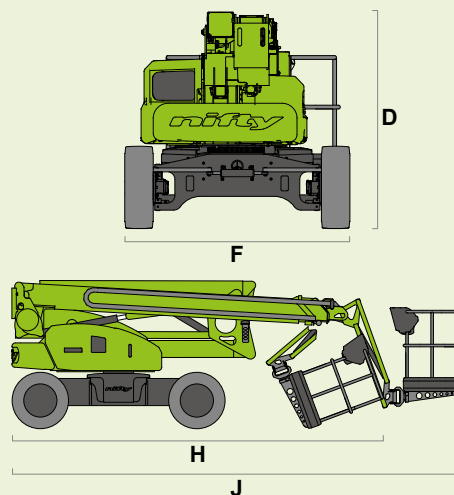
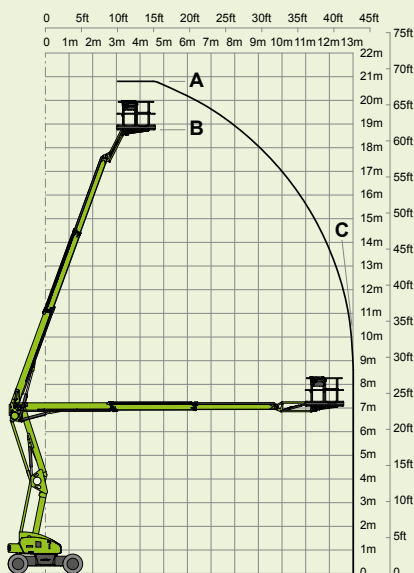